

268704

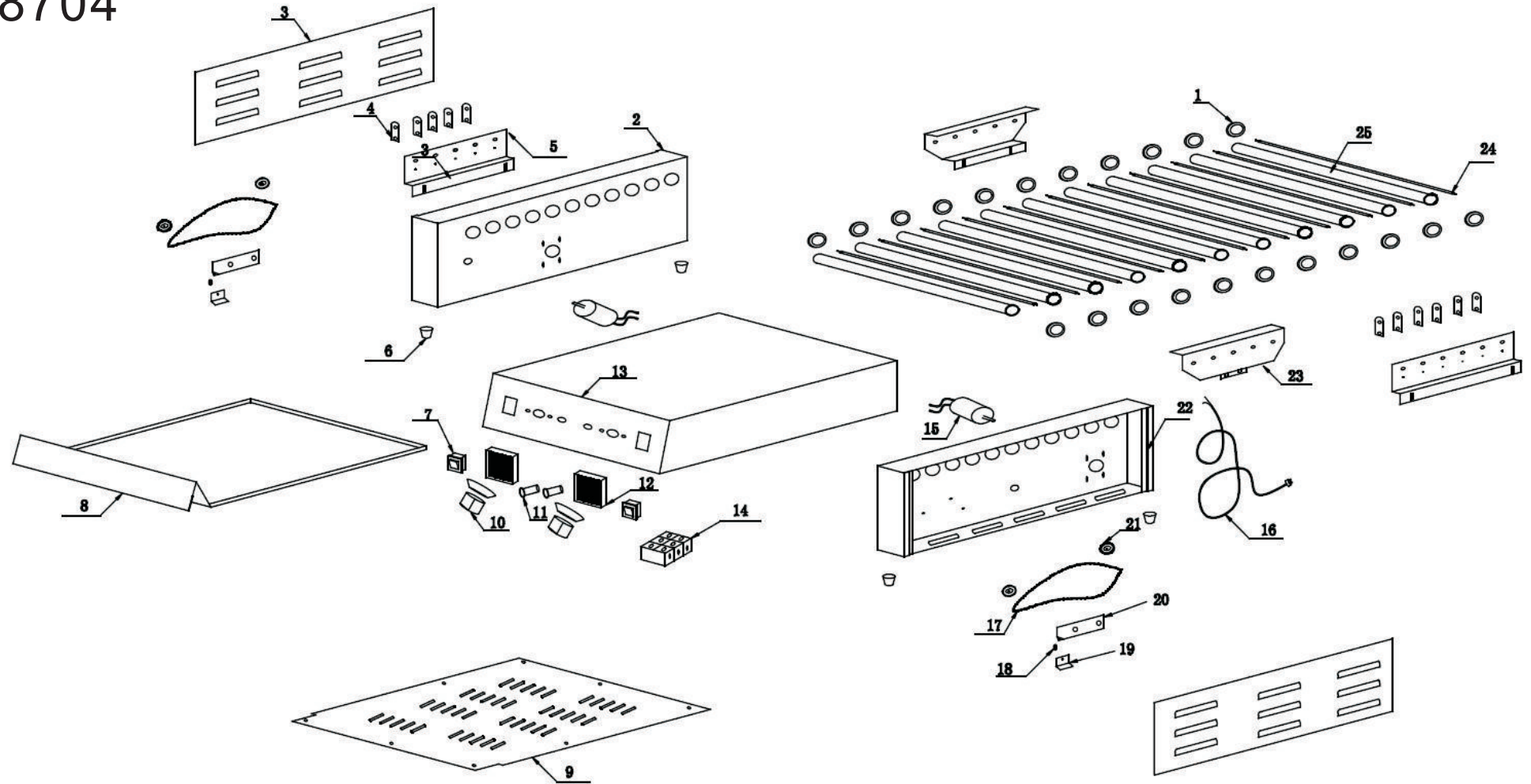

1	plastic ring	9	bottom plate	17	chain
2	left housing	10	knob & ring	18	spring
3	left panel	11	indication lamp	19	spring bracket
4	connection plate	12	energy regulator	20	gear bracket
5	left bracket	13	main housing	21	washer
6	rubber feet	14	wire connector	22	right housing
7	rocker switch	15	motor	23	right bracket
8	dripping tray	16	power cord	24	heating element
				25	roller